

USER'S MANUAL

SOFTWARE VERSION 3.2x
code 80225C / Edition 04 - 03/08



1 • INSTALLATION

• Dimensions and cut-out; panel mounting

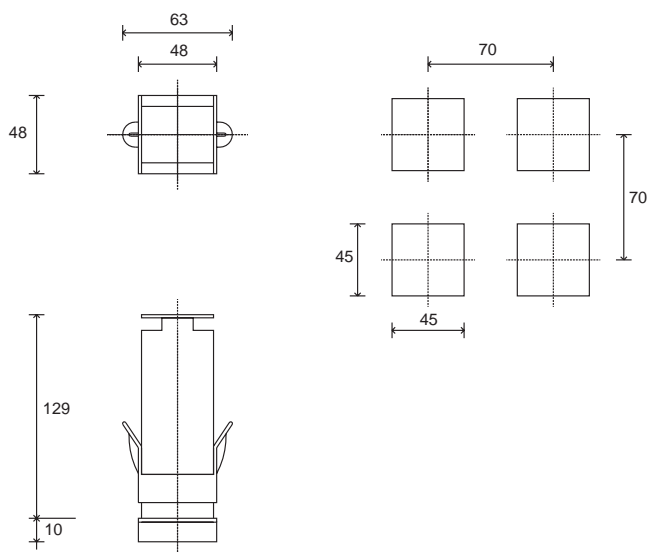

For correct and safe installation, follow the instructions and observe the warnings contained in this manual.

Panel mounting:

To fix the unit, insert the brackets provided into the seats on either side of the case. To mount two or more units side by side, respect the cut-out dimensions shown in the drawing.

CE MARKING: EMC conformity (electromagnetic compatibility) with EEC Directive 89/336/CEE with reference to the generic Standard EN61000-6-2 (immunity in industrial environments) and EN50081-1 (emission in residential environments). BT (low voltage) conformity respecting the Directive 73/23/CEE modified by the Directive 93/68.

MAINTENANCE: Repairs must be done only by trained and specialized personnel. Cut power to the device before accessing internal parts.

Do not clean the case with hydrocarbon-based solvents (Petrol, Trichlorethylene, etc.). Use of these solvents can reduce the mechanical reliability of the device. Use a cloth dampened in ethyl alcohol or water to clean the external plastic case.

SERVICE: GEF 800 has a service department. The warranty excludes defects caused by any use not conforming to these instructions.

2 • TECHNICAL SPECIFICATIONS

Display	2 x 4 digits, green, height 10 and 7mm
Keys	4 mechanical keys (Man/Auto, INC, DEC, F)
Accuracy	0.2% full scale at 25°C room temperature
Main input	TC, RTD (Pt100 - JPT100), PTC, 50mV, Ri ≥ 1MΩ, 10V, Ri ≥ 10KΩ, 20mA, Ri = 50W
Thermocouples	IEC 584-1 (J, K, R, S, T, B, E, N, Ni-Ni18Mo, L NiCr-CuNi)
Cold junction error	0,1° / °C
RTD type (scale configurable within indicated range, with or without decimal point)	DIN 43760 (Pt100, JPT100)
PTC type (on request)	990Ω, 25°C
Max line resistance for RTD	20Ω
Safety	detection of short-circuit or opening of probes, LBA alarm, HB alarm
°C / °F selection	configurable from faceplate
Linear scale ranges	-1999 to 9999 with configurable decimal point position
Controls	PID, Self-tuning, on-off
pb / dt / di	0.0 ... 999.9% / 0.00 ... 99.99min / 0.00 ... 99.99min
Action	Heat / Cool
Control outputs	on / off, pwm
Cycle time	0.1 ... 200 sec
Main output type	Relay, Logic, Continuous (optional)
Softstart	0.0 ... 500.0 min
Maximum power limit heat / cool	0.0 ... 100.0 %
Fault power setting	-100.0 ... 100.0 %
Automatic blanking	Optional exclusion, displays PV value
Configurable alarms	3 configurable alarms type: max, min, symmetrical, absolute or relative, LBA, HB
Alarm masking	- exclusion during warm up - latching reset from faceplate or external contact
Type of relay contact	NO (NC), 5A, 250V, cosφ = 1
Logic output for static relays	11Vdc, Rout = 220Ω (6V/20mA)
Remote setpoint or ammeter input (options)	0 ... 10V, 2 ... 10V, Ri ≥ 1MΩ 0 ... 20mA, 4 ... 20mA, Ri = 5Ω Potentiometer > 500Ω, CT 50mAac, 50/60Hz, Ri = 1.5Ω, isolation 1500V
CT scale range	configurable from 0, ... , 100.0A
Transmitter power supply (optional)	filtered 10 / 24Vdc, max 30mA short-circuit protection, isolation 1500V
Analogue retransmission signal (optional)	10V / 20mA, isolation 1500V
Logic inputs (optional)	24V NPN, 4.5mA; 24V PNP, 3.6mA isolation 1500V
Serial interface (optional)	CL; RS422/485; RS232; isolation 1500V
Baud rate	1200 ... 19200
Protocol	GEFRAN / MODBUS
Power supply (switching type)	(std) 100 ... 240Vac/dc ±10%; 50/60Hz, 12VA max (opt.) 20...27Vac/dc ±10%; 50/60Hz, 12VA max
Faceplate protection	IP65
Working / Storage temperature range	0...50°C / -20...70°C
Relative humidity	20 ... 85% non-condensing
Environmental conditions of use	for internal use only, altitude up to 2000m
Installation	Panel, plug-in from front
Weight	210g for the complete version

EMC conformity has been tested with the following connections

FUNCTION	CABLE TYPE	LENGTH
Power supply cable	1 mm ²	1 m
Relay output cable	1 mm ²	3.5 m
Digital communication cable	0,35 mm ²	3.5 m
C.T. connection cable	1,5 mm ²	3.5 m
TC input	0,8 mm ² compensated	5 m
Pt100 input	1 mm ²	3 m

3 • DESCRIPTION OF FACEPLATE

Function indicators
Indicates modes of operation
MAN = OFF (Automatic control)
MAN = ON (Manual control)
AUX = OFF (IN1 = OFF - local Setpoint 1)
AUX = ON (IN1 = ON - local Setpoint 2)
REM = OFF (local Setpoint)
REM = ON (remote Setpoint)

Indication of output states
OUT 1 (Main); OUT 2 (AL 1);
OUT 3 (AL 2); OUT 4 (HB)

Automatic/Manual adjustment selection
Active only when PV display visualises the process variable

"Raise" and "Lower" key
Press to increment (decrement) any numerical parameter •• Increment (decrement) speed is proportional to time key stays pressed •• The operation is not cyclic: once the maximum (minimum) value of a field is reached, the value will not change even if the key remains pressed.

PV Display: Indication of process variable
Error Indication: LO, HI, Sbr, Err
LO= the value of process variable is < di LO_S
HI= the value of process variable is > di HI_S
Sbr= faulty sensor or input values higher than max. limits
Err= PT100 third wire opened for PT100, PTC or input values lower than min. limits (i.e.: TC wrong connection)

SV display: Indication of setpoint

Function key
Gives access to the various configuration phases •• Confirms change of set parameters and browses next or previous parameter (if Auto/Man key is pressed)

4 • CONNECTIONS

Serial line

Configurable serial line isolated to 1500V
Passive current loop (max. 1200 baud)

RS422/485 or RS232 (optional)

Output

Out4 (AL3/HB) (W1)	7	User configurable generic output	6	User configurable generic output
-	8	- 5A/250Vac relay, cosφ=1 - 11Vdc logic, Rout = 220Ω (6V/20mA) - analogue output isolated to 1500V (0...10V, 0...20/4...20mA)	5	Out3 (AL2)
+				

Outputs

Out2 (AL1)	19	User configurable generic output
-	20	- 5A/250Vac relay, cosφ = 1 - 11Vdc logic, Rout = 220Ω (6V/20mA)
+	21	
Out1 (Main)	22	
-		
+		

Power Supply

PWR	23	Standard: 100...240Vac/Vdc
	24	Optional: 20...27Vac/Vdc 50/60Hz

Auxiliary input

- ~	14	Auxiliary input isolated 1500V
+	13	Current transformer 50mAac, 1,5Ω, 50/60Hz
		Remote setpoint 0...20, 4...20mA, 5Ω 0...1V, 0...10V, > 1MΩ

Transmitter supply

GND	11	Transmitter supply isolated 1500V
+Vt	12	10/24Vdc, max. 30mA short-circuit protection

Inputs

Pt100 2-wires or PTC

Pt100 3-wires

TC

Available thermocouples: J, K, R, S, T, B, E, N, Ni-Ni18Mo, L NiCr-CuNi
- Observe polarities
- For extensions, use the correct compensating cable for the type of TC used

Linear (V)

Linear input in dc voltage 0...50mV, 10...50mV, 0...10V, 2...10V

Linear (I)

Linear input in dc current 0...20mA, 4...20mA

Digital inputs / Out 5

Out 5 analogue (W2) (alternative to IN2 digital input)	9	+	Digital input isolated to 1500V - NPN 24V, 4.5mA - PNP 24V, 3.6mA (12V, 3.6mA) (IN2 alternative Out 5)	9	IN2
(*) terminal 11 if Out 4 is Relay or Logic	7	COM (*)		10	IN1
				11	COM

5 • RECOMMENDED WIRING LAYOUT

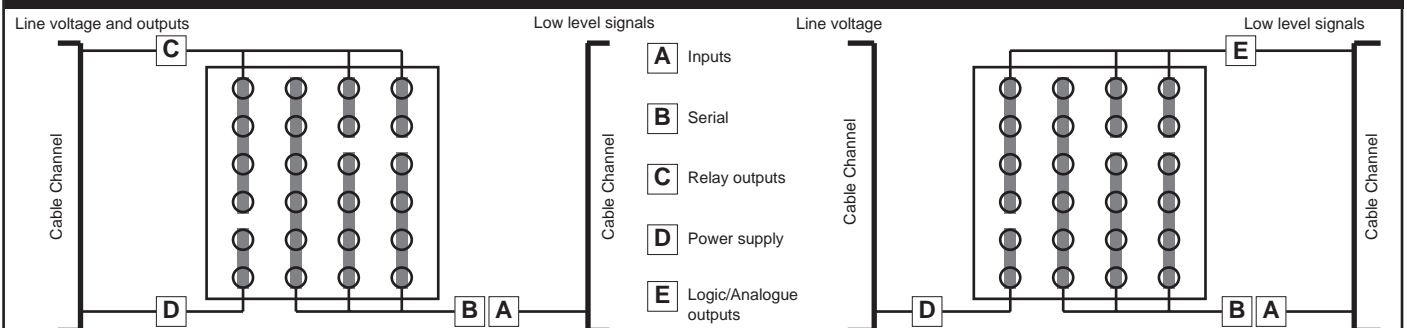

Device structure: identification of boards

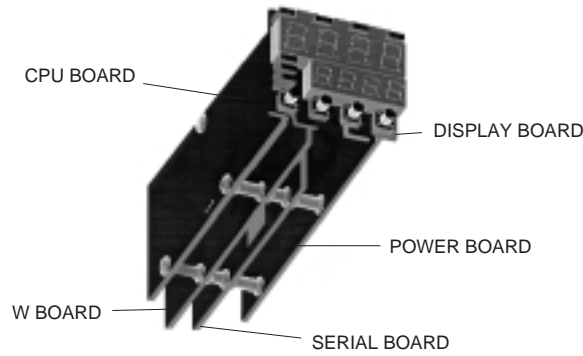

5 • PROGRAMMING and CONFIGURATION

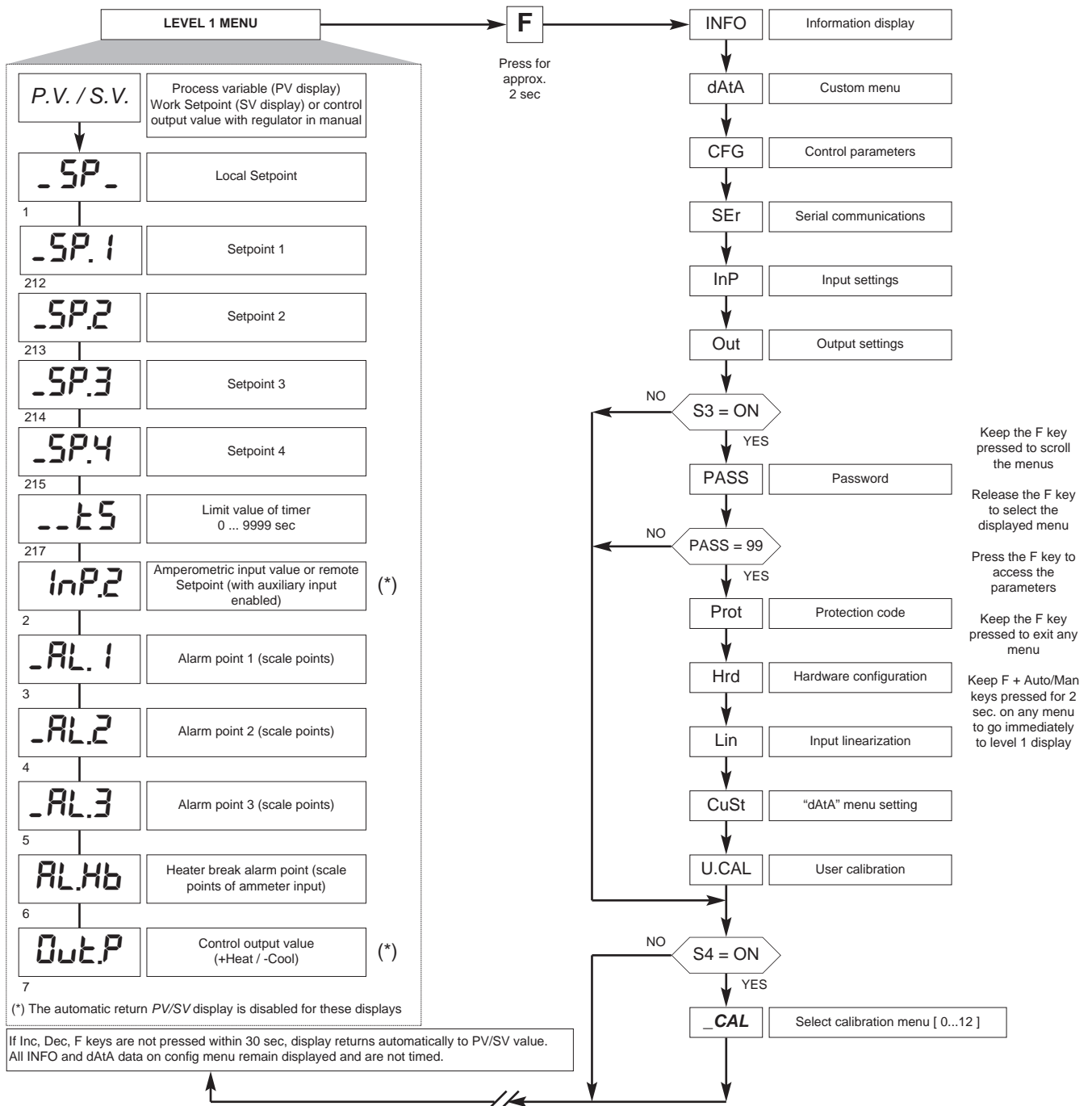

N.B.: Once a particular configuration is entered, all unnecessary parameters are no longer displayed

• InFo Display



• CFG

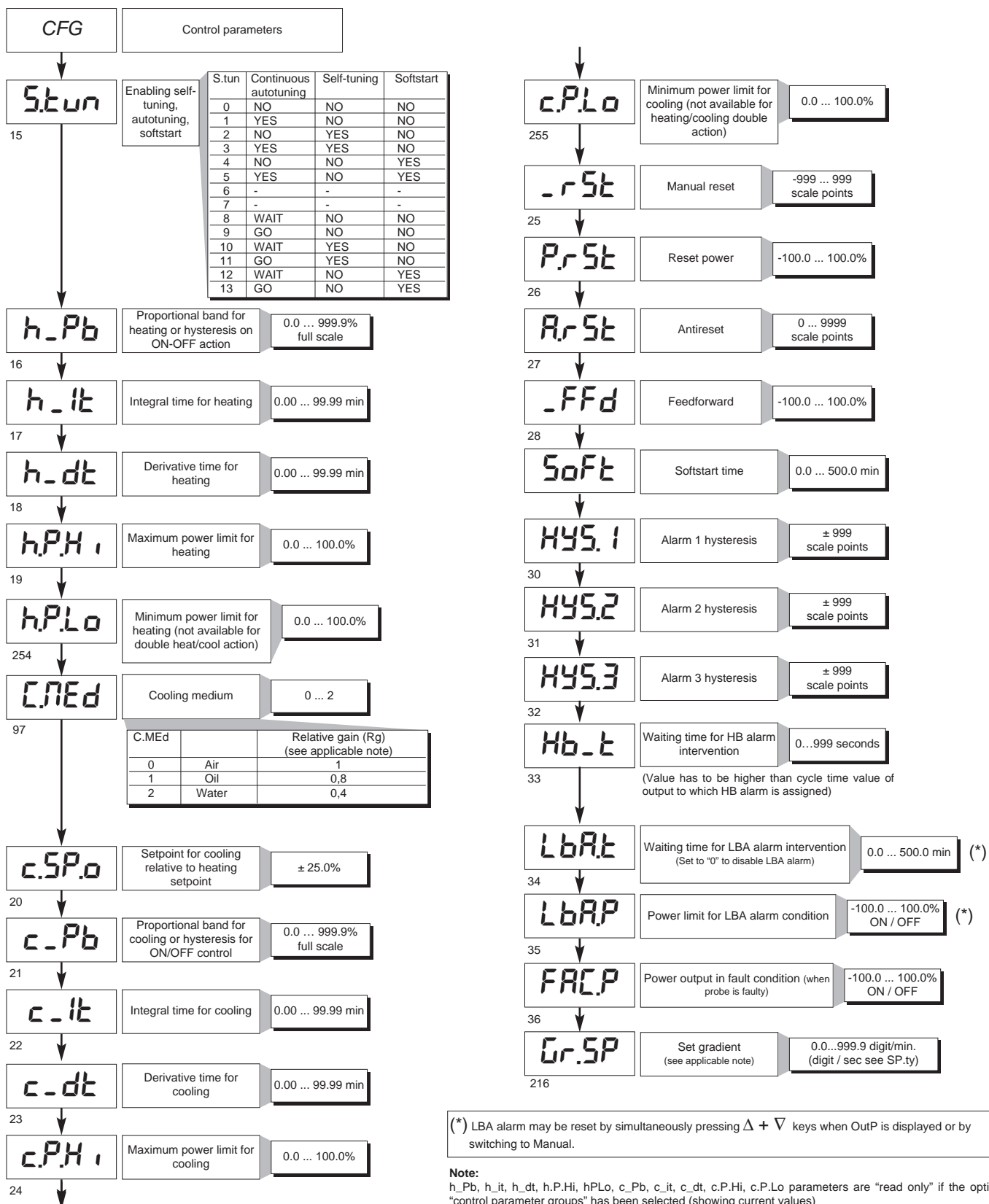

• Ser

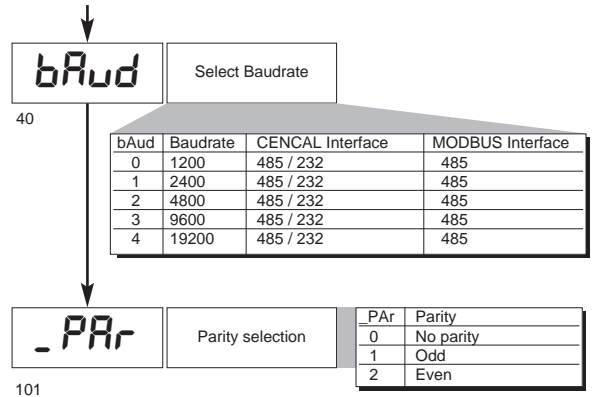
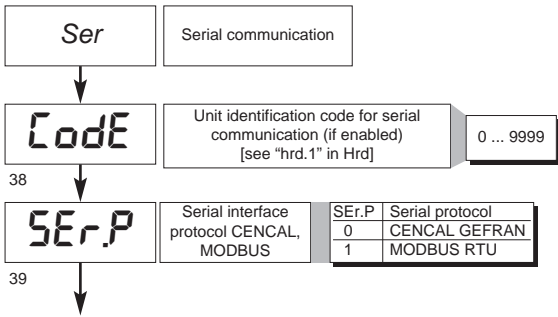

• InP

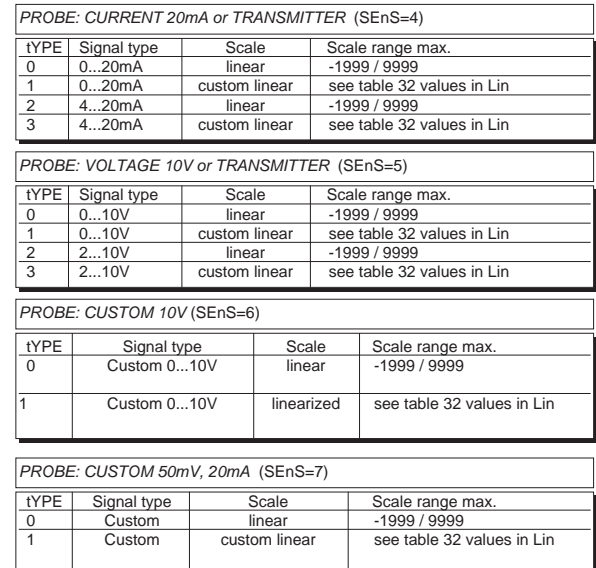
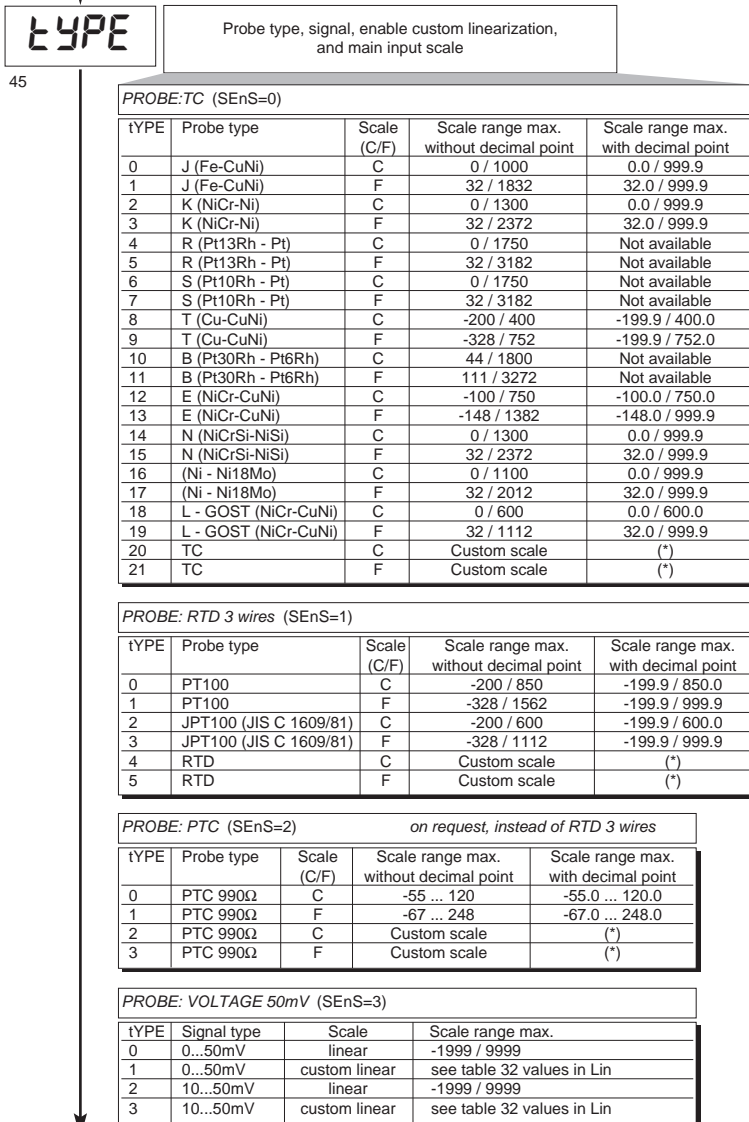
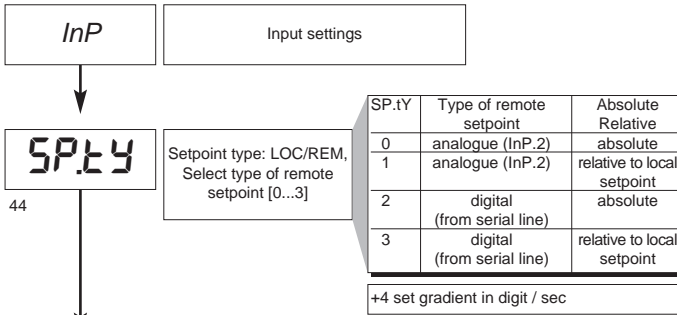

(*) Linearization and scale limit settings (with or without decimal point) are selectable from PC via serial line

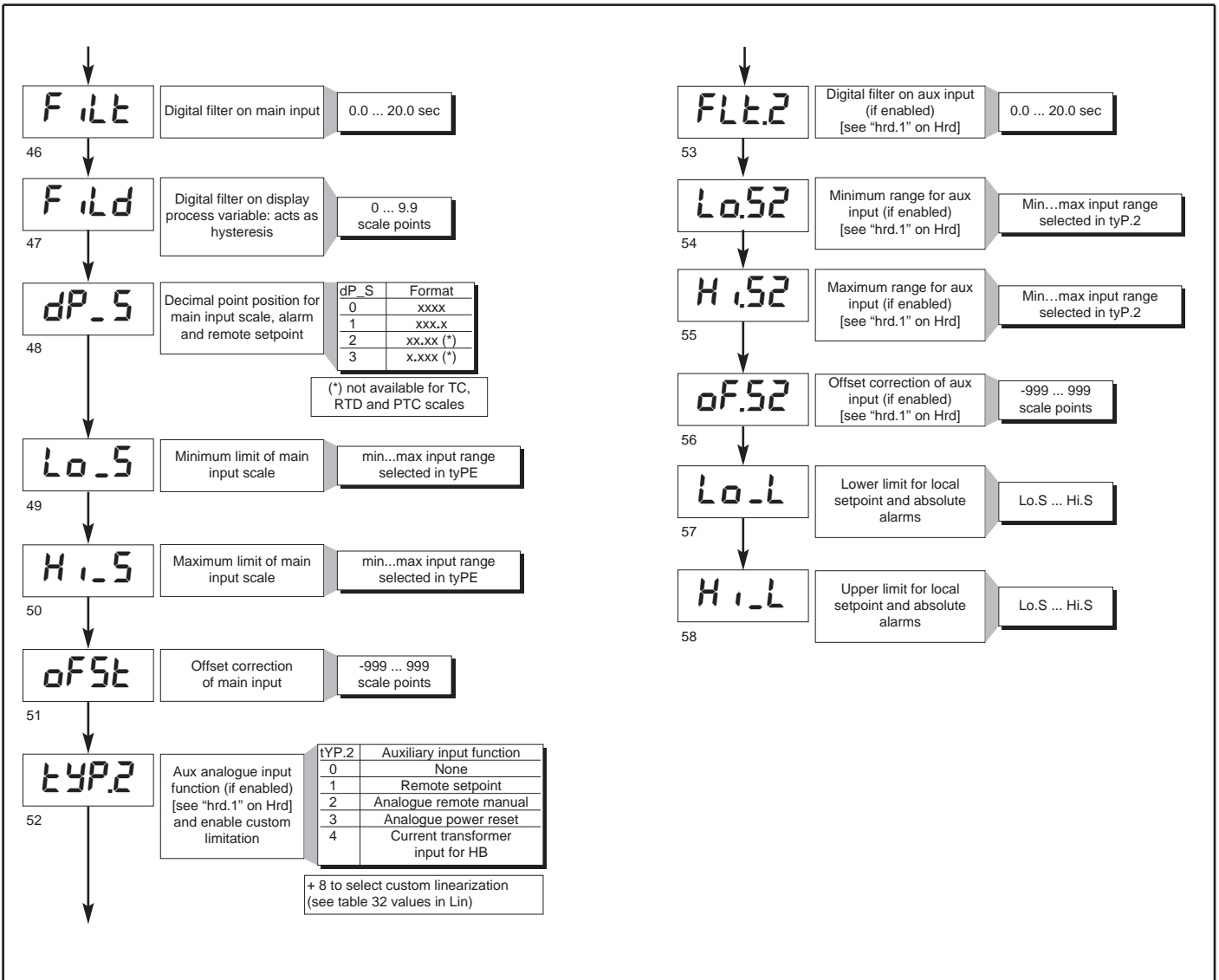

• Out

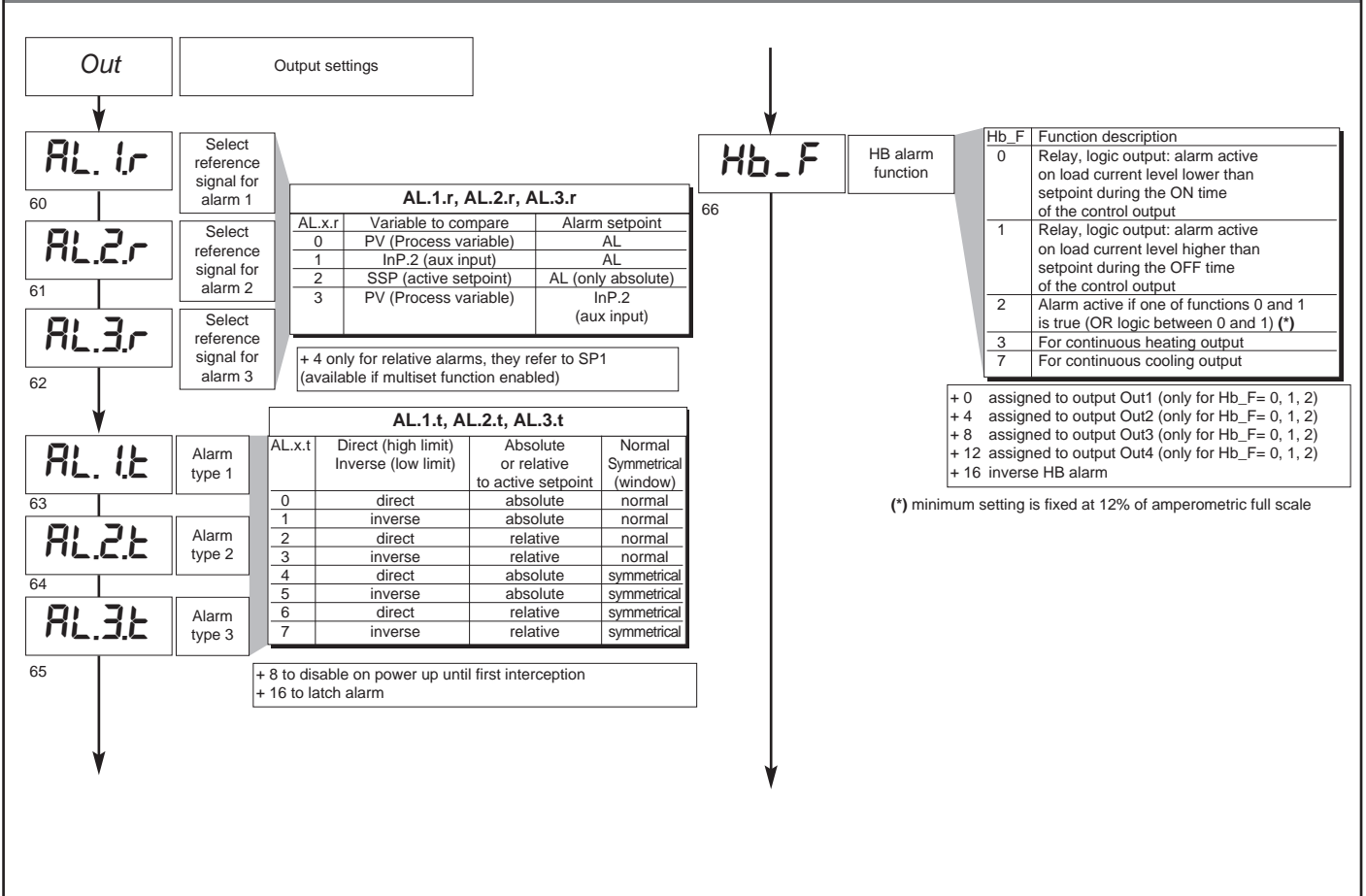

67

rLo.1

Out 1
Allocation of reference signal: HEAT, COOL, AL1, AL2, AL3, repetition of digital inputs

68

rLo.2

Out 2
Allocation of reference signal: HEAT, COOL, AL1, AL2, AL3, repetition of digital inputs

69

rLo.3

Out 3
Allocation of reference signal: HEAT, COOL, AL1, AL2, AL3, repetition of digital inputs

70

rLo.4

Out 4
Allocation of reference signal: HEAT, COOL, AL1, AL2, AL3, repetition of digital inputs

rL.o.x	Function of main output relay/logic (OUT1)
0	HEAT (control output for heating)
1	COOL (control output for cooling)
2	AL1 - alarm 1
3	AL2 - alarm 2
4	AL3 - alarm 3
5	AL.HB - alarm HB
6	LBA - alarm LBA
7	IN1 - repetition of logic input 1
8	IN2 - repetition of logic input 2
9	-
10	-
11	-
12	Repeat Timer
13	Repeat Set / Reset
14	(AL1) OR (AL2)
15	(AL1) OR (AL2) OR (AL3)
16	(AL1) AND (AL2)
17	(AL1) AND (AL2) AND (AL3)
18	(HBAL) OR (AL1)
19	(HBAL) OR (AL1) OR (AL2)
20	(HBAL) AND (AL1)
21	(HBAL) AND (AL1) AND (AL2)

+ 32 for inverse logic signal output

64	Heat control output with fast cycle time (*)
65	Cool control output with fast cycle time (*)

(*) only for rL.o.1.; HB alarm is disabled if associated with Out1 output

71

-Ct.1

Cycle time for MAIN relay or logic output = HEAT or COOL

1 ... 200 sec
(0.1 ... 20.0 sec)

72

-Ct.2

Cycle time for AL1 relay or logic output = HEAT or COOL

1 ... 200 sec

73

-Ct.3

Cycle time for AL2 relay or logic output = HEAT or COOL

1 ... 200 sec

74

-Ct.4

Cycle time for AL3 relay or logic output = HEAT or COOL

1 ... 200 sec

75

-rEL.

Fault action (sets state in case of probe fault) Alarm outputs AL1, AL2, AL3; Select intrinsic safety

rEL.	Alarm 1	Alarm 2	Alarm 3
0	OFF	OFF	OFF
1	ON	OFF	OFF
2	OFF	ON	OFF
3	ON	ON	OFF
4	OFF	OFF	ON
5	ON	OFF	ON
6	OFF	ON	ON
7	ON	ON	ON

Note:
1) In case of broken probe, logic state of individual alarm assumes selected logic value without consideration of alarm type (direct or inverse): ON=alarm active; OFF=alarm inactive
2) Assign alarms to available outputs by entering codes rLo1, rLo2, rLo3, rLo4.

78

An.o.1

Out W1
Assignment of signal or reference value: PV, SP, SP-PROG, DEV+, DEV-, IN.AUX, HEAT, COOL, AL1, AL2, AL3, serial line value

An.o.x	Reference value
0	PV - process variable
1	SSP - active setpoint
2	SP - local setpoint
3	InP.2 - aux input
4	Deviation (SSP-PV)
5	HEAT (*)
6	COOL (*)
7	AL1 (alarm point)
8	AL2 (alarm point)
9	AL3 (alarm point)
10	AL.HB - (alarm point)
11	Value acquired from serial line

+ 16 for inverted output with respect to reference value
+ 32 for output with 2...10V, 4...20mA signal

(*) - Fixed scale limits
- Retransmission output not available with ON/OFF control action

76

LAn.1

Minimum limit of analogue repetition signal output 1

-100.0...100.0% for power
-1999...9999 for inputs and setpoint

77

HAn.1

Maximum limit of analogue repetition signal output 1

-100.0...100.0% for power
-1999...9999 for inputs and setpoint

81

An.o.2

Out W2.
Assignment of signal or reference value: PV, SP, SP-PROG, DEV+, DEV-, IN.AUX, HEAT, COOL, AL1, AL2, AL3, serial line value

79

LAn.2

Minimum limit of analogue repetition signal output 2

-100.0...100.0% for power
-1999...9999 for inputs and setpoint

80

HAn.2

Maximum limit of analogue repetition signal output 2

-100.0...100.0% for power
-1999...9999 for inputs and setpoint

• Prot

42

Prot

Protection code

Prot	Display	Modification
0	SP, InP2, alarms, OutP, INFO, DATA	SP, alarms, DATA
1	SP, InP2, alarms, OutP, INFO, DATA	SP, alarms
2	SP, InP2, alarms, OutP, INFO	SP
3	SP	

- + 4 to disable InP, Out
- + 8 to disable CFG, Ser,
- + 16 to disable SW "power-up - power down"
- + 32 disable manual power latching
- + 64 to disable manual power modification

• Hrd

Hrd Hardware configuration

hrd.1 Auxiliary input installation, digital inputs, serial interface. Timer and multiset enabling

hrd.1	Aux analogue input	Logic input 1 (IN1)	Logic input 2 (IN2)	Serial interface
0				
1	x			
2		x		
3	x	x		
4			x	
5	x		x	
6		x	x	
7	x	x	x	
8				x
9	x			x
10		x		x
11	x	x		x
12			x	x
13	x		x	x
14		x	x	x
15	x	x	x	x

+16 to enable the Timer function
 +32 to enable the Multiset function (2SP)
 +64 to enable the Multiset function (4SP)

hrd.2 Installation of relay, logic outputs MAIN, AL1, AL2, AL3, and analogue outputs W1, W2

hrd.2	OUT 1 (relay, logic)	OUT 2 (relay, logic)	OUT 3 (relay, logic)	OUT 4 (relay, logic)
0				
1	x			
2		x		
3	x	x		
4			x	
5	x		x	
6		x	x	
7	x	x	x	
8				x
9	x			x
10		x		x
11	x	x		x
12			x	x
13	x		x	x
14		x	x	x
15	x	x	x	x

+ 16 to enable analogue output W1
 + 32 to enable analogue output W2
 + 64 to invert state of LEDs compared to state of output

hrd.3 0 Non significant function

Ctrl Control type [0...78]

Ctrl	Control type
0	P heat
1	P cool
2	P heat / cool
3	PI heat
4	PI cool
5	PI heat / cool
6	PID heat
7	PID cool
8	PID heat / cool
9	ON-OFF heat
10	ON-OFF cool
11	ON-OFF heat / cool
12	PID heat + ON-OFF cool
13	ON-OFF heat + PID cool
14	PID heat + cool with relative gain (see C.MED parameter)

Selection of derivative action sampling time:
 + 0 sample 1 sec.
 + 16 sample 2 sec.
 + 32 sample 8 sec.
 + 64 sample 240 msec.

Note: LbA alarm is not enabled with ON/OFF type control

_SSt. Start / Stop Timer

0	from enabled digital input
1	from AL1 ON
2	from AL2 ON
3	from AL3 ON
4	from ALHB ON
5	from serial line (address 0049H, bit 0)
6	from serial line (address 0049H, bit 1)
7	from keys

_rt. Reset Timer (0 ... 15)

+8 inverse action
 +16 Autoreset enabled (Stop = program reset) (only for _S.S.t. parameter)

SEnS Selection of probe type for main input

SEnS	Probe type for main input
0	Thermocouple (TC)
1	Resistance Thermometer (RTD)
2	Thermistor (PTC)
3	Voltage 0...50mV / 10...50mV
4	Current 0...20mA / 4...20mA
5	Voltage 0...10V / 2...10V
6	Custom 10V
7	Custom max 50mV

+ 8 to enable main input curve 4 point correction (alternative to custom linearization). See description in "Main Input Correction Function" section.
 +16 to disable averaging filter on sampled value (available from software release 3.05)

Note: scale selection with "tYPE" code in InP

SnS.2 Selection of probe type for aux input

SnS.2	Signal
0	0 ... 1V
1	0.2 ... 1V
2	0 ... 10V
3	2 ... 10V
4	0 ... 20mA
5	4 ... 20mA
6	Potentiometer
7	CT 50mA ~

+8 to disable averaging filter on sampled value (available from software release 3.05)

ALnr Select number of enabled alarms

AL.nr	Alarm 1	Alarm 2	Alarm 3
0	disabled	disabled	disabled
1	enabled	disabled	disabled
2	disabled	enabled	disabled
3	enabled	enabled	disabled
4	disabled	disabled	enabled
5	enabled	disabled	enabled
6	disabled	enabled	enabled
7	enabled	enabled	enabled

+ 8 to enable HB alarm
 + 16 to enable LBA alarm

butt Function of M/A keys: "****"

butt	Function
0	No function (key disabled)
1	MAN / AUTO controller
2	LOC / REM
3	HOLD
4	Start / Stop selftuning
5	Start / Stop autotuning
6	Set / Reset outputs Out 1... Out 4
7	Alarms memory reset
8	SP1 / SP2 Selection
9	Integral contribution instantaneous zero setting
10	Start / Stop Timer (se S.S.t. = 7)
11	Reset Timer (se _rt = 7)

+16 disable function in configuration menu

but.2 0 Non significant function

d.i.F.1 Function of digital input 1 (IN1)

d.i.F.1, d.i.F.2	Function
0	No function (disabled input.)
1	MAN / AUTO controller
2	LOC / REM
3	HOLD
4	Start / Stop timer
5	Reset timer
6	Software on/off
7	Alarms memory reset
8	SP1...SP2 (2SP) Selection
9	SP1...SP4 – bit Lo Selection
9	SP1...SP4 – bit Hi Selection

+ 16 for inverse logic input
 + 32 to force logic state 0 (OFF)
 + 48 to force logic state 1 (ON)

d.i.F.2 Function of digital input 2 (IN2)

d.SP Defining SV display function

d.SP	Lower display (SV) function
(*) 0	SSP - setpoint enabled
(*) 1	InP.2 - aux input
(*) 2	Control output value
(*) 3	Deviation (SSP - PV)
8	Visualisation of current time on PV display and tS time on SV display

(*) + 4 Timer in start

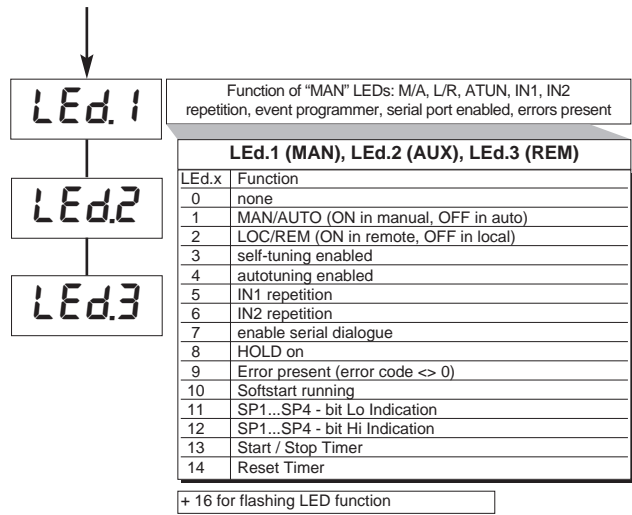

• Lin

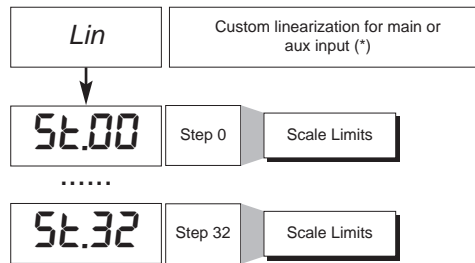

(*) Not available for :
 enabled input correction function (SenS + 8)
 TC custom input type (SenS = 0; tyPE = 20,21)
 RTD custom input type (SenS = 1; tyPE = 4,5)

• CuSt

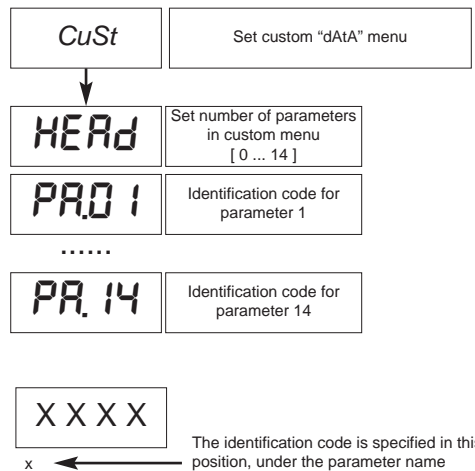

• U.CAL

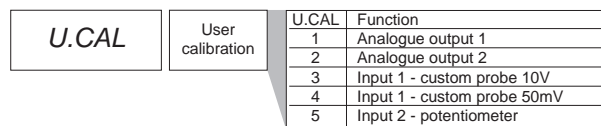

6 • TIMER + 2 SET POINT, TIMER FUNCTION

The timer functionality is enabled in **Hrd** configuration in **hrd.1** parameter setting the code +16 or +48 to activate the selection of two set points. In the case of enabling, parameters **_S.S.t.** (start/stop timer) and **_r.t.** (reset timer) define the functioning modality. The intervention threshold of the **tS** timer can be set at level 1 of programming with bottom of scale 9999 sec. The enabling to the timer, as also the reset condition, can occur due to external contact or alarm conditions (AL1, AL2, AL3, ALHb). The reset function, always active on the status, zero sets the value of the timer and keeps it blocked even if the start is present. In the absence of enabling (stop) the autoreset condition can be active for which the timer zero sets at each stop. It is possible to make the timer visible on the SV display during the active counting phase as specified by the **diSP** parameter. On reaching the preset time (**tS**), it is possible to activate a relay of the four available or select set point 2.

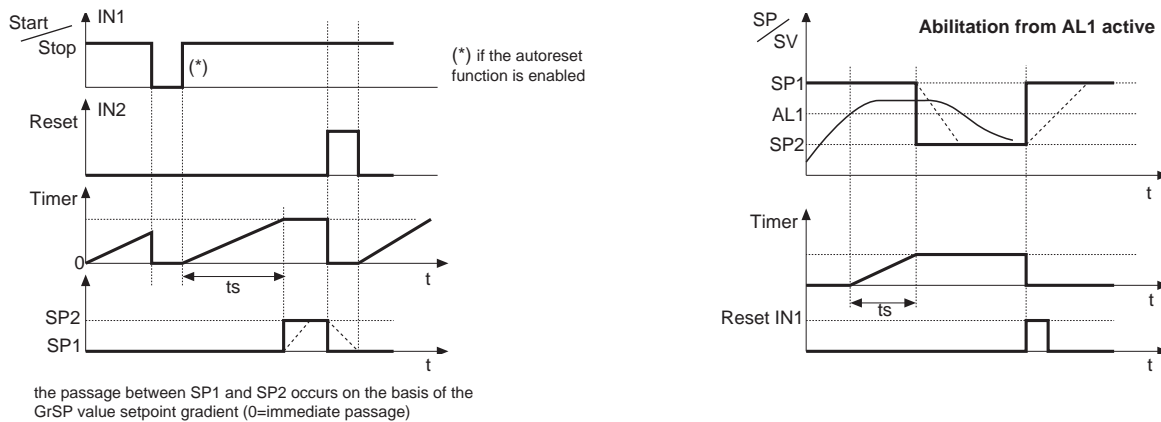

7 • MULTISET FUNCTION, SET GRADIENT

The function is enabled in **Hrd** configuration in the parameter **hrd.1** setting code +64. It allows the setting of 4 set points which can be selected by means of combinations of digital inputs (IN1, IN2). The selection between set point 1 and set point 2 can also be carried out by means of front key. It is possible to visualise the selection between set point 1 / 2 using leds. **SET GRADIENT**: if set $\neq 0$, when switching on and during the auto/man passage the set point is assumed to be equal to PV, with gradient set it reaches the local set or that selected. Every set variation is subject to gradient. The set gradient is inhibited on switching on when the self tuning is enabled. If the set gradient is set $\neq 0$, this is active even on local setpoint variations, which can be set only in the relative SP menu. The adjustment setpoint reaches the value set with a speed defined by the gradient.

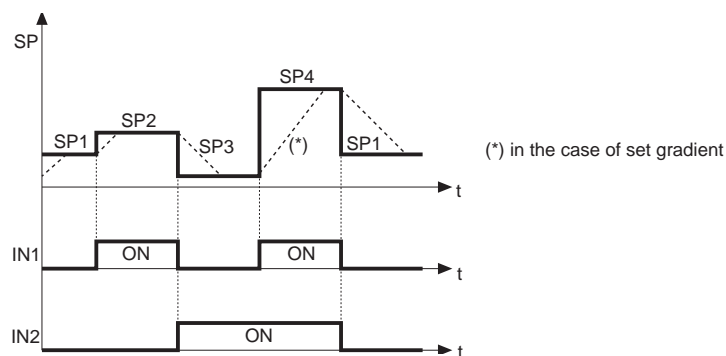

8 • ALARMS

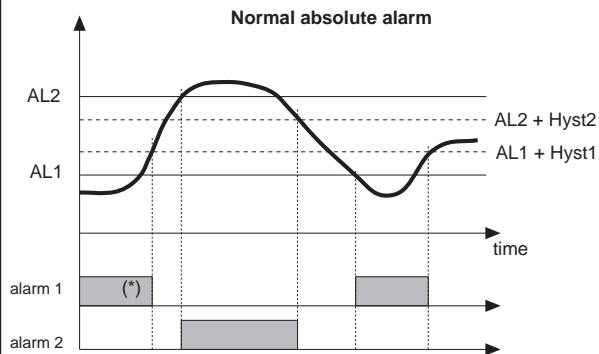

For AL1 = reverse absolute alarm (low) with positive Hyst1, AL1 t = 1
 (*) = OFF if disabled on power-up
 For AL2 = direct absolute alarm (high) with negative Hyst2, AL2 t = 0

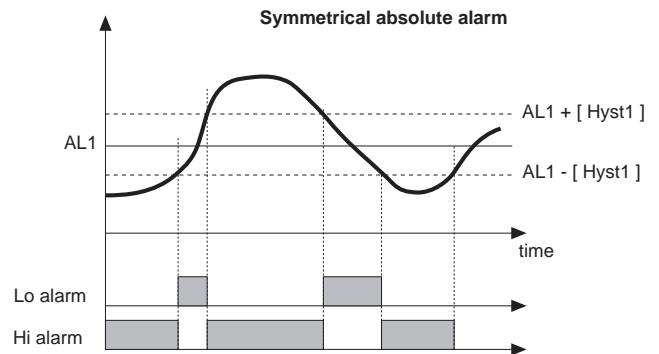

For AL1 = symmetrical reverse absolute alarm with Hyst1, AL1 t = 5
 For AL1 = symmetrical direct absolute alarm with Hyst1, AL1 t = 4

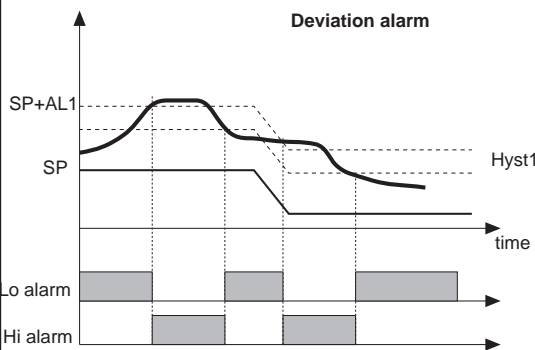

For AL1 = reverse deviation alarm with negative Hyst 1, AL1 t = 3
 For AL1 = direct deviation alarm with negative Hyst 1, AL1 t = 2

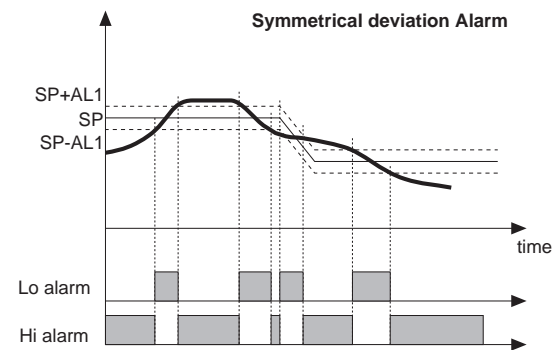

For AL1 = Symmetrical reverse deviation alarm with Hyst 1, AL1 t = 7
 For AL1 = Symmetrical direct deviation alarm with Hyst 1, AL1 t = 6

HB ALARM

This type of alarm requires use of a current transformer input (TA).

It can indicate variations of load current measured through transformer input in the range (Lo.S2 ... HI.S2).

It is enabled by means of configuration code (Hrd, AL.nr); in this case the alarm setpoint is expressed as HB scale points.

The alarm function and the assigned control output are selected through parameter Hb_F ("Out" phase).

The alarm setpoint is AL.Hb.

The direct HB alarm trips if current transformer input falls below the setpoint for Hb_t seconds of ON time for the selected output.

The HB alarm can be activated only with ON times exceeding 0.4 seconds.

The HB alarm monitors load current even during the OFF period of the cycle time of the selected output.

The HB alarm will trip if measured current exceeds 12% of the CT input full scale for Hb_t seconds when the output is in OFF state.

The alarm is reset automatically when alarm conditions have been cleared.

If AL.Hb is set at = 0, both types of HB alarm are disabled and the assigned relay is de-energized.

The load current reading is displayed by selecting InP2 (level 1).

NOTE: ON/OFF times refer to the cycle time set for the selected output.

Alarm Hb_F = 3 (7), for analog output is ON when the load current is lower than the alarm setpoint; the alarm is disabled if the heating (cooling) output is lower than 2%.

LBA ALARM

This alarm detects an interruption in the control loop caused by a possible short-circuited probe, inverted probe connections or broken load.

If enabled (AL.nr), the alarm trips if the variable does not increase when heating (reduce when cooling) at maximum power for a set time (LbA.t).

The value of the variable is enabled only outside the proportional band; when the alarm is ON, power is limited to value (LbA.P).

The alarm condition resets as soon as temperature increases for heating (or reduces for cooling), or by simultaneously pressing the "V" and "Δ" keys in Out.P of level 1.

The LBA function is disabled if LbA.t = 0.

9 • SOFT-START

This function (if enabled) partializes power in proportion to the time elapsed since power-up compared to the preset time 0.0 ... 500.0 min ("SoFt" parameter, CFG). Soft-start is an alternative to self-tuning and is activated each time the unit is powered up. The soft-start function is reset by switching to Manual control.

10 • CONTROL ACTIONS

Proportional Action:

action in which contribution to output is proportional to deviation at input (deviation = difference between controlled variable and setpoint).

Derivative Action:

action in which contribution to output is proportional to rate of variation input deviation.

Integral Action:

action in which contribution to output is proportional to integral of time of input deviation.

Influence of Proportional, Derivative and Integral actions on response of process under control

* An increase in P.B. reduces oscillations but increases deviation.

* A reduction in P.B. reduces the deviation but provokes oscillations of the controlled variable (the system tends to be unstable if P.B. value is too low).

* An increase in Derivative Action corresponds to an increase in Derivative Time, reduces deviation and prevents oscillation up to a critical value of Derivative Time, beyond which deviation increases and prolonged oscillations occur.

* An increase in Integral Action corresponds to a reduction in Integral Time, and tends to eliminate deviation between the controlled variable and the setpoint when the system is running at rated speed.

If the Integral Time value is too long (Weak integral action), deviation between the controlled variable and the setpoint may persist.

Contact GEFTRAN for more information on control actions.

11 • MANUAL TUNING

A) Enter the setpoint at its working value.

B) Set the proportional band at 0.1% (with on-off type setting).

C) Switch to automatic and observe the behavior of the variable.

It will be similar to that in the figure:

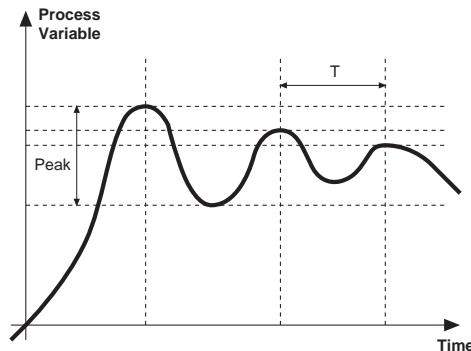

D) The PID parameters are calculated as follows: Proportional band

$$\text{P.B.} = \frac{\text{Peak}}{(V \text{ max} - V \text{ min})} \times 100$$

(V max - V min) is the scale range.

Integral time: $I_t = 1.5 \times T$

Derivative time: $d_t = I_t/4$

E) Switch the unit to manual, set the calculated parameters. Return to PID action by setting the appropriate relay output cycle time, and switch back to Automatic.

F) If possible, to optimize parameters, change the setpoint and check temporary response. If an oscillation persists, increase the proportional band. If the response is too slow, reduce it.

12 • SOFTWARE ON / OFF SWITCHING FUNCTION

How to switch the unit OFF: hold down the "F" and "Raise" keys simultaneously for 5 seconds to deactivate the unit, which will go to the OFF state while keeping the line supply connected and keeping the process value displayed. The SV display is OFF.

All outputs (alarms and controls) are OFF (logic level 0, relays de-energized) and all unit functions are disabled except the switch-on function and digital communication.

How to switch the unit ON: hold down the "F" key for 5 seconds and the unit will switch OFF to ON. If there is a power failure during the OFF state, the unit will remain in OFF state at the next power-up (ON/OFF state is memorized).

The function is normally enabled, but can be disabled by setting the parameter Prot = Prot +16. This function can be assigned to a digital input (d.i.F.1 or d.i.F.2) and excludes deactivation from the keyboard.

13 • SELF-TUNING

The function works for single output systems (heating or cooling).

The self-tuning action calculates optimum control parameter values during process startup.

The variable (for example, temperature) must be that assumed at zero power (room temperature).

The controller supplies maximum power until an intermediate value between starting value and setpoint is reached, after which it zeros power.

PID parameters are calculated by measuring overshoot and the time needed to reach peak. When calculations are finished, the system disables automatically and the control proceeds until the setpoint is reached.

How to activate self-tuning:

A. Activation at switch-on

1. Switch program to STOP
2. Adjust setpoint to required value
3. Enable self-tuning by setting **Stun** parameter to 2 (CFG menu)
4. Switch unit off
5. Make sure that temperature is approximately room temperature
6. Switch the unit on

B. Activation from keyboard

1. Make sure that M/A key is enabled for Start/Stop self-tuning function (**butt** code = 4 Hrd menu)
2. Switch program to STOP
3. Adjust temperature to approximately room temperature
4. Adjust setpoint to required value
5. Press M/A key to activate self-tuning (Attention: self-tuning will be disabled if the key is pressed again).

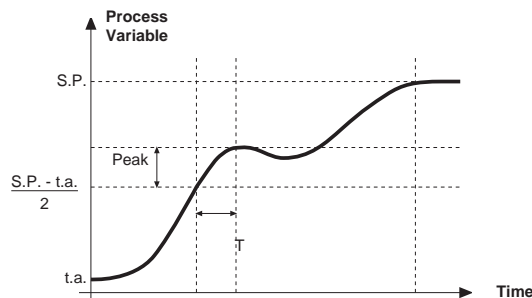

The procedure runs automatically until finished, when the new PID parameters are stored: proportional band, integral and derivative times calculated for the active action (heating or cooling). In case of double action (heating or cooling), parameters for the opposite action are calculated by maintaining the initial ratio between parameters (ex.: $CPb = HPb * K$; where $K = CPb / HPb$ when self-tuning starts). When finished, the **Stun** code is automatically cancelled.

Notes:

- The procedure interrupts when the setpoint value is exceeded. In this case, the **Stun** code is not cancelled.
- It is good practice to enable one of the configurable LEDs to signal self-tuning status. By setting one of LED1, LED2, LED3 = 3 (or 19) on the Hrd menu, the corresponding LED will be on (or flashing) when self-tuning is active.
- For the programmer model, the program is in STOP if self-tuning is activated when the unit is switched on.

14 • AUTO-TUNING

PID parameters cannot be set if the self-tuning function is enabled.

The function can be one of two types: permanent or one-shot.

The first continuously measures system oscillations to find the optimum PID values to reduce such oscillations.

It does not engage if the oscillations drop below 1.0% of the proportional band.

It is interrupted if the setpoint is changed, and is automatically resumed when the setpoint stabilizes.

The calculated parameters are not stored.

If the unit is switched off, the controller reverts to the values set before self-tuning was enabled.

One-shot self-tuning is useful for calculating values around a setpoint. It produces a variation of 10% of current power at the output and examines the effect of the overshoot over time. These parameters are stored and replace those previously set. After this disturbance, the controller resumes control at the setpoint using the new parameters. The parameter activated in CFG is accepted only if the control power is between 20 and 80%.

15 • CONTROL OUTPUT

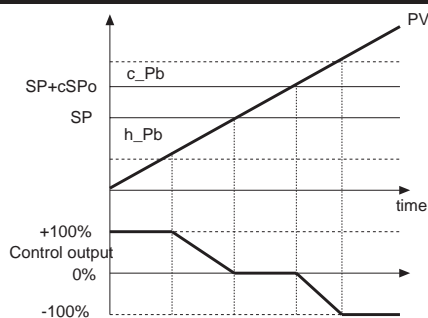

Control output with proportional action only if proportional heating band is separated from proportional cooling band.

PV = Process Value
 SP+cSPo = Cooling Setpoint
 c_Pb = Proportional cooling band

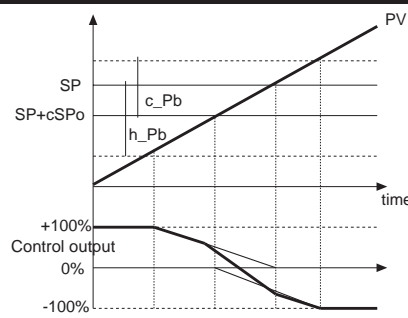

Control output with proportional action only if proportional heating band overlaps proportional cooling band.

SP = Heating Setpoint
 h_Pb = Proportional heating band

Heating/Cooling control with relative gain

In this control mode (enabled with Ctrl = 14 parameter) the type of cooling has to be specified.

Cooling PID parameters are therefore calculated based on heating parameters according to the specified ratio.

(for example: c.MEd = 1 (oil), H_Pb = 10, H_dt = 1, H_lt = 4 implies: C_Pb = 12,5, C_dt = 1, C_lt = 4)

We advise you to apply the following values when setting output cycle times:

- Air T Cool Cycle = 10 sec.
- Oil T Cool Cycle = 4 sec.
- Water T Cool Cycle = 2 sec.

NB.: Cooling parameters **cannot be modified** in this mode.

16 • MAIN INPUT CORRECTION FUNCTION

Lets you custom correct reading of the main input by setting four values: A1, B1, A2, B2.

This function is enabled by setting "Sens" +8 code ("Hrd" menu).

Example: Sens = 1+8 = 9 for RTD probe with input correction.

The scale can be reversed if this function is applied to linear scales (50mv, 10V, 20mA, Pot).

The four values are set on the "Lin" menu as follows: A1 = St100, B1 = St01, A2 = St02, B2 = St03. Setting is limited to the defined scale ("LoS" ... "HiS" on "InP" menu).

The offset function ("oFt" parameter on "InP" menu) remains enabled.

Limits:

B1 always greater than A1;

B1-A1 at least 25% of full scale of selected probe.

Example:

Sens = 9, TyPE = 0 (Pt100 natural scale -200...+600), dPS = 0

LoS = 0, HiS = 400, oFt = 0

Reference point on real curve:

A1 = St00 = 50, B1 = St01 = 350 (B1-A1 = 300, greater than 25% of 800)

Corresponding points on corrected curve: A2 = St02 = 120, B2 = St03 = 220

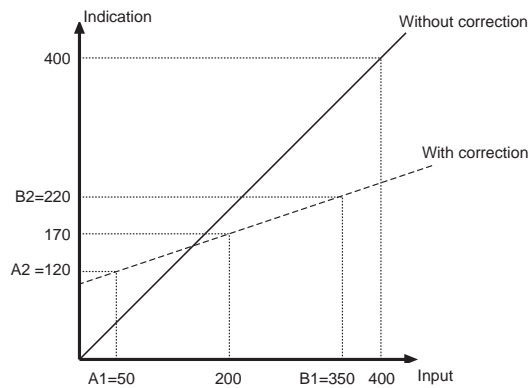

17 • ACCESSORIES

• CURRENT TRANSFORMER

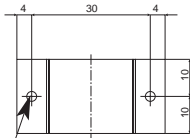
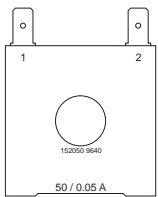

Hole for 2.9 x 9 self-threading screws

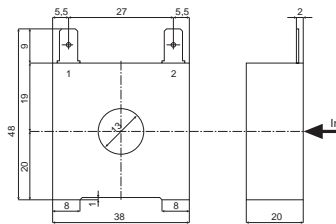

These transformers are used to measure currents of 50 ÷ 60Hz from 25A to 600A

(nominal primary current). The peculiar characteristic of these transformers is the high number of secondary turns. This provides a very low secondary current, suitable for an electronic measurement circuit. The secondary current may be detected as voltage on a resistor.

• ORDER CODE

CODE	Ip / Is	∅ Secondary Wire	n	OUTPUTS	Ru	Vu	ACCURACY
TA/152 025	25 / 0.05A	0.16 mm	n ₁₋₂ = 500	1 - 2	40 Ω	2 Vac	2.0 %
TA/152 050	50 / 0.05A	0.18 mm	n ₁₋₂ = 1000	1 - 2	80 Ω	4 Vac	1.0 %

COD. 330200	IN = 50Aac OUT = 50mAac
COD. 330201	IN = 25Aac OUT = 50mAac

• RS232 interface for instrument configuration

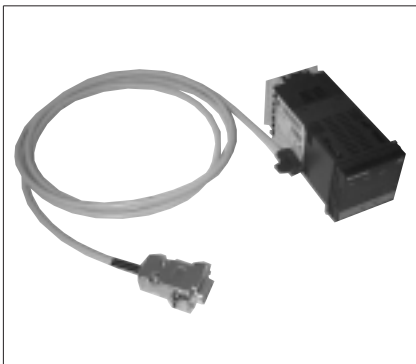

N.B.: RS232 interface for PC configuration is supplied with configuration software.

The digital communication connection must be executed with unit ON and inputs/outputs not connected.

• ORDER CODE

WSK-0-0-0	Cable Interface + CD Winstrum
-----------	----------------------------------

ORDER CODE

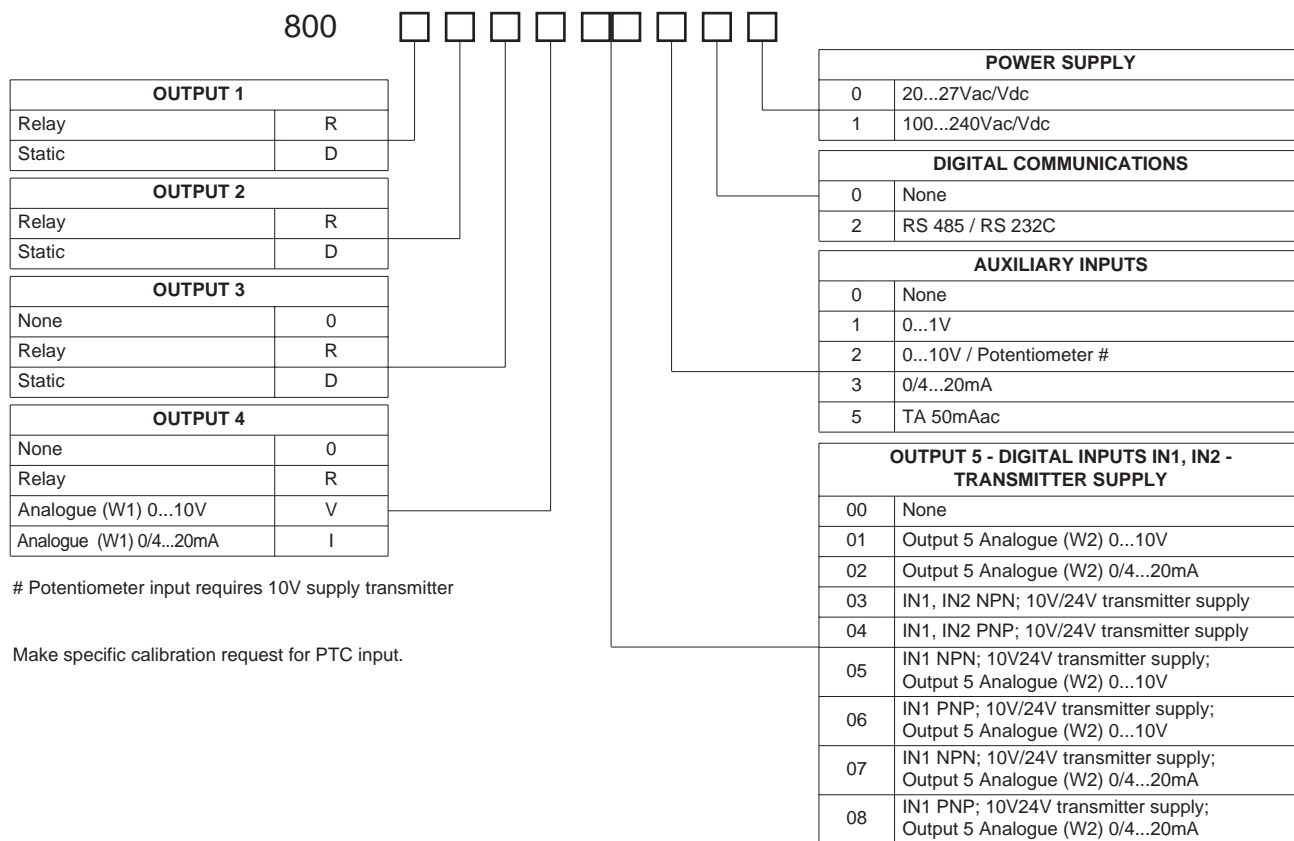

Please, contact GEFRA sales people for the codes availability.

• WARNINGS



WARNING: this symbol indicates danger. It is placed near the power supply circuit and near high-voltage relay contacts.

Read the following warnings before installing, connecting or using the device:

- follow instructions precisely when connecting the device.
- always use cables that are suitable for the voltage and current levels indicated in the technical specifications.
- the device has no ON/OFF switch: it switches on immediately when power is turned on. For safety reasons, devices permanently connected to the power supply require a two-phase disconnecting switch with proper marking. Such switch must be located near the device and must be easily reachable by the user. A single switch can control several units.
- if the device is connected to electrically NON-ISOLATED equipment (e.g. thermocouples), a grounding wire must be applied to assure that this connection is not made directly through the machine structure.
- if the device is used in applications where there is risk of injury to persons and/or damage to machines or materials, it MUST be used with auxiliary alarm units. You should be able to check the correct operation of such units during normal operation of the device.
- before using the device, the user must check that all device parameters are correctly set in order to avoid injury to persons and/or damage to property.
- the device must NOT be used in inflammable or explosive environments. It may be connected to units operating in such environments only by means of suitable interfaces in conformity to local safety regulations.
- the device contains components that are sensitive to static electrical discharges. Therefore, take appropriate precautions when handling electronic circuit boards in order to prevent permanent damage to these components.

Installation: installation category II, pollution level 2, double isolation

- power supply lines must be separated from device input and output lines; always check that the supply voltage matches the voltage indicated on the device label.
 - install the instrumentation separately from the relays and power switching devices
 - do not install high-power remote switches, contactors, relays, thyristor power units (particularly if "phase angle" type), motors, etc... in the same cabinet.
 - avoid dust, humidity, corrosive gases and heat sources.
 - do not close the ventilation holes; working temperature must be in the range of 0...50°C.
- If the device has faston terminals, they must be protected and isolated; if the device has screw terminals, wires should be attached at least in pairs.
- **Power:** supplied from a disconnecting switch with fuse for the device section; path of wires from switch to devices should be as straight as possible; the same supply should not be used to power relays, contactors, solenoid valves, etc.; if the voltage waveform is strongly distorted by thyristor switching units or by electric motors, it is recommended that an isolation transformer be used only for the devices, connecting the screen to ground; it is important for the electrical system to have a good ground connection; voltage between neutral and ground must not exceed 1V and resistance must be less than 60hm; if the supply voltage is highly variable, use a voltage stabilizer for the device; use line filters in the vicinity of high frequency generators or arc welders; power supply lines must be separated from device input and output lines; always check that the supply voltage matches the voltage indicated on the device label.
 - **Input and output connections:** external connected circuits must have double insulation; to connect analog inputs (TC, RTD) you have to: physically separate input wiring from power supply wiring, from output wiring, and from power connections; use twisted and screened cables, with screen connected to ground at only one point; to connect adjustment and alarm outputs (contactors, solenoid valves, motors, fans, etc.), install RC groups (resistor and capacitor in series) in parallel with inductive loads that work in AC (Note: all capacitors must conform to VDE standards (class x2) and support at least 220 VAC. Resistors must be at least 2W); fit a 1N4007 diode in parallel with the coil of inductive loads that operate in DC.

GEFRAN spa will not be held liable for any injury to persons and/or damage to property deriving from tampering, from any incorrect or erroneous use, or from any use not conforming to the device specifications.

PONTICELLI PER CONFIGURAZIONE
JUMPERS FOR CONFIGURATION
BRÜCKEN FÜR KONFIGURATION

PONTS ÉTAIN POUR CONFIGURATION
PUNTES PARA CONFIGURACIÓN
PONTES PARA CONFIGURAÇÃO

Struttura dello strumento: identificazione schede
 Device structure: identification of boards
 Aufbau des Instruments: Leiterplatten
 Structure de l'appareil: identification des cartes
 Estructura del instrumento: identificación fichas
 Estrutura do instrumento: identificação das placas

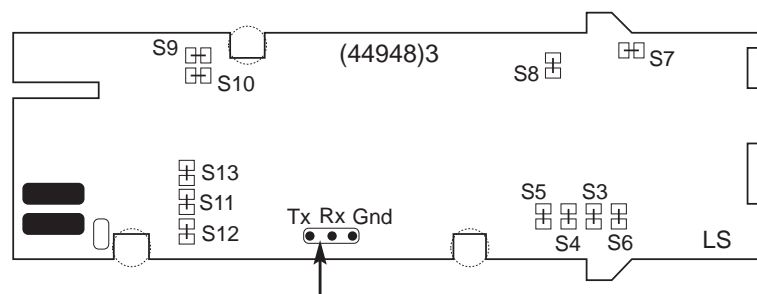

SCHEDA CPU
 CPU BOARD
 CPU-KARTE
 CARTE CPU
 FICHA CPU
 PLACA CPU

Connettore per collegamento seriale
 Connector for serial connection
 Steckverbinder für seriellen Anschluss
 Connecteur pour raccordement série
 Conector para conexión serie
 Conector para ligação serial

DESCRIZIONE DESCRIPTION BESCHREIBUNG	PONTICELLI JUMPERS BRÜCKEN
Abilitazione configurazione Enable configuration Freigabe der Konfiguration	S3 (chiuso) S3 (closed) S3 (geschlossen)
Abilitazione calibrazione Enable calibration Freigabe der Kalibration	S4 (chiuso) S4 (closed) S4 (geschlossen)
OUT3 relé diseccitato power ON OUT3 relay OFF at power ON Ausgang 3; Relais angezogen = Kontakt geöffnet	S9 (chiuso) S9 (closed) S9 (geschlossen)
OUT3 relé eccitato power ON OUT3 relay ON at power ON Ausgang 3; Relais angezogen = Kontakt geschlossen	S10 (chiuso) S10 (closed) S10 (geschlossen)
Abilitazione autoconfigurazione istantanea Enable instantaneous self-configuration Freigabe sofortige automatische Konfigurierung	S8 (assieme a S3+S4) (chiusi) S8 (with S3+S4) (closed) S8 (mit S3+S4) (geschlossen)
Non utilizzato Not used Nicht verwendet	S7 (chiuso) S7 (closed) S7 (geschlossen)
Abilitazione ingresso da potenziometro Enable input from potentiometer Freigabe des Potentiometereingangs	S11 (chiuso) S11 (closed) S11 (geschlossen)
Abilitazione ingresso da potenziometro Enable input from potentiometer Freigabe des Potentiometereingangs	S12 (chiuso) S12 (closed) S12 (geschlossen)
Abilitazione sonda PTC Enable PTC probe Freigabe Fühler PTC	S13 (aperto) S13 (open) S13 (geöffnet)
Abilitazione sonda PT100 Enable PT100 probe Freigabe Fühler PT100	S13 (chiuso) S13 (closed) S13 (geschlossen)

DESCRIPTION DESCRIPCIÓN DESCRIÇÃO	PONTS ÉTAIN PUENTES PONTES
Validation configuration Habilitación configuración Habilitação da configuração	S3 (fermée) S3 (cerrado) S3 (fechado)
Validation étalonnage Habilitación calibración Habilitação da calibração	S4 (fermée) S4 (cerrado) S4 (fechado)
OUT3 relais désexcité mise en marche OUT3 relé desexcitado con "power ON" OUT3 relé não excitado com alimentação ON	S9 (fermée) S5 (cerrado) S9 (fechado)
OUT3 relais excité mise en marche OUT3 relé excitado con "power ON" OUT3 relé excitado com alimentação ON	S10 (fermée) S10 (cerrado) S10 (fechado)
Validation autoconfiguration instantanée Habilitación autoconfiguración instantánea Habilitação da auto-configuração instantânea	S8 (avec S3+S4) (fermées) S8 (con S3+S4) (cerrados) S8 (com S3+S4) (fechados)
Non utilisé No utilizado Não utilizado	S7 (fermée) S7 (cerrado) S7 (fechado)
Validation entrér par potentiomètre Habilitación entrada desde potenciómetro Habilitação entrada proveniente do potenciômetro	S11 (fermée) S11 (cerrado) S11 (fechado)
Validation entrér par potentiomètre Habilitación entrada desde potenciómetro Habilitação entrada proveniente do potenciômetro	S12 (fermée) S12 (cerrado) S12 (fechado)
Validation capteur PTC Habilitación sonda PTC Habilitação para sonda PTC	S13 (ouverte) S13 (abierto) S13 (aberto)
Validation capteur PT100 Habilitación sonda P100 Habilitação para sonda PT100	S13 (fermée) S13 (cerrado) S13 (fechado)

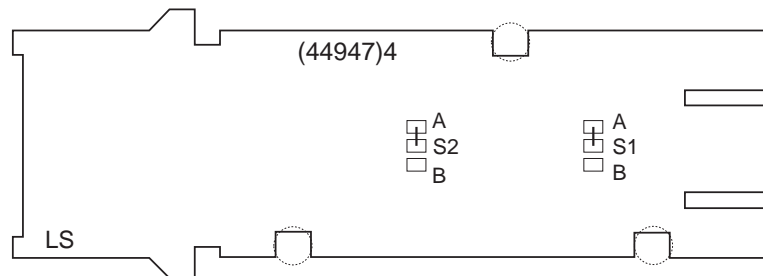

SCHEDA POWER 90/260
POWER BOARD 90/260
NETZTEIL-KARTE 90/260

CARTE ALIMENTATION 90/260
FICHA ALIMENTACIÓN 90/260
PLACA DE ALIMENTAÇÃO 90/260

DESCRIZIONE DESCRIPTION BESCHREIBUNG DESCRIPCIÓN DESCRIÇÃO	PONTICELLI JUMPERS BRÜCKEN PONTS ÉTAIN PUENTES PONTES
OUT2 relè disexcitato power ON OUT2 relay OFF at power ON Ausgang 2; Relais angezogen = Kontakt geöffnet OUT2 relais désexcité mise en marche OUT2 relé desexcitado con "power ON" OUT2 relé não excitado com alimentação ON	S1 (posizione A) S1 (position A) S1 (Stellung A) S1 (position A) S1 (posición A) S1 (posição A)
OUT2 relè eccitato power ON OUT2 relay ON at power ON Ausgang 2; Relais angezogen = Kontakt geschlossen OUT2 relais excité mise en marche OUT2 relé excitado con "power ON" OUT2 relé excitado com alimentação ON	S1 (posizione B) S1 (position B) S1 (Stellung B) S1 (position B) S1 (posición B) S1 (posição B)

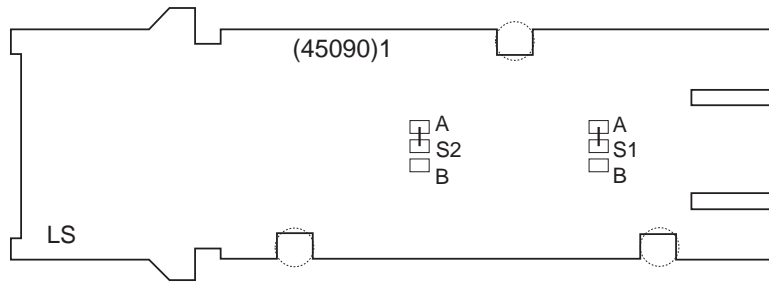

SCHEDA POWER 10/30
 POWER BOARD 10/30
 NETZTEIL-KARTE 10/30
 CARTE ALIMENTATION 10/30
 FICHA ALIMENTACIÓN 10/30
 PLACA DE ALIMENTAÇÃO 10/30

DESCRIZIONE DESCRIPTION BESCHREIBUNG DESCRIPTION DESCRIPCIÓN DESCRIÇÃO	PONTICELLI JUMPERS BRÜCKEN PONTS ÉTAIN PUNTES PONTES
OUT2 relè diseccitato power ON OUT2 relay OFF at power ON Ausgang 2; Relais angezogen = Kontakt geöffnet OUT2 relais désexcité mise en marche OUT2 relé desexcitado con "power ON" OUT2 relé não excitado com alimentação ON	S1 (posizione A) S1 (position A) S1 (Stellung A) S1 (position A) S1 (posición A) S1 (posição A)
OUT2 relè eccitato power ON OUT2 relay ON at power ON Ausgang 2; Relais angezogen = Kontakt geschlossen OUT2 relais excité mise en marche OUT2 relé excitado con "power ON" OUT2 relé excitado com alimentação ON	S1 (posizione B) S1 (position B) S1 (Stellung B) S1 (position B) S1 (posición B) S1 (posição B)

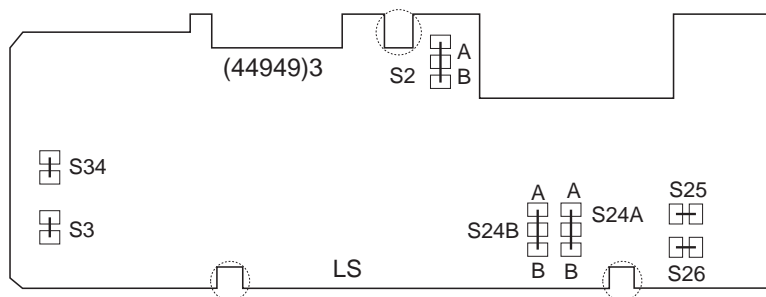

SCHEDA OUT W / INGRESSI DIGITALI
 OUT W BOARD / DIGITAL INPUTS
 ANALOG AUSGÄNGE / DIGITALE EINGÄNGE
 CARTE OUT W / ENTREES NUMERIQUES
 FICHA OUT W / ENTRADAS DIGITALES
 PLACA OUT W / ENTRADAS DIGITAIS

DESCRIZIONE DESCRIPTION BESCHREIBUNG DESCRIPTION DESCRIPCIÓN DESCRIÇÃO	PONTICELLI JUMPERS BRÜCKEN PONTS ÉTAIN PUENTES PONTES
OUT4 relè diseccitato power ON OUT4 relay OFF at power ON Ausgang 4; Relais angezogen = Kontakt geöffnet OUT4 relais désexcité mise en marche OUT4 relé desexcitado con "power ON" OUT4 relé não excitado com alimentação ON	S2 (posizione A) S2 (position A) S2 (Stellung A) S2 (position A) S2 (posición A) S2 (posição A)
OUT4 relè eccitato power ON OUT4 relay ON at power ON Ausgang 4; Relais angezogen = Kontakt geschlossen OUT4 relais excité mise en marche OUT4 relé excitado con "power ON" OUT4 relé excitado com alimentação ON	S2 (posizione B) S2 (position B) S2 (Stellung B) S2 (position B) S2 (posición B) S2 (posição B)
Selezione ingresso logico 1 NPN Selection of 1 NPN logic input Wahl des Digital-Eingangs 1 NPN Sélection entrée logique 1 NPN Selección entrada lógica 1 NPN Seleção entrada lógica 1 NPN	S24A (posizione A) S24A (position A) S24A (Stellung A) S24A (position A) S24A (posición A) S24A (posição A)
Selezione ingresso logico 1 PNP Selection of 1 PNP logic input Wahl des Digital-Eingangs 1 PNP Sélection entrée logique 1 PNP Selección entrada lógica 1 PNP Seleção entrada lógica 1 PNP	S24A (posizione B) S24A (position B) S24A (Stellung B) S24A (position B) S24A (posición B) S24A (posição B)
Selezione ingresso logico 2 NPN Selection of 2 NPN logic input Wahl des Digital-Eingangs 2 NPN Sélection entrée logique 2 NPN Selección entrada lógica 2 NPN Seleção entrada lógica 2 NPN	S24B (posizione A) S24B (position A) S24B (Stellung A) S24B (position A) S24B (posición A) S24B (posição A)
Selezione ingresso logico 2 PNP Selection of 2 PNP logic input Wahl des Digital-Eingangs 2 PNP Sélection entrée logique 2 PNP Selección entrada lógica 2 PNP Seleção entrada lógica 2 PNP	S24B (posizione B) S24B (position B) S24B (Stellung B) S24B (position B) S24B (posición B) S24B (posição B)

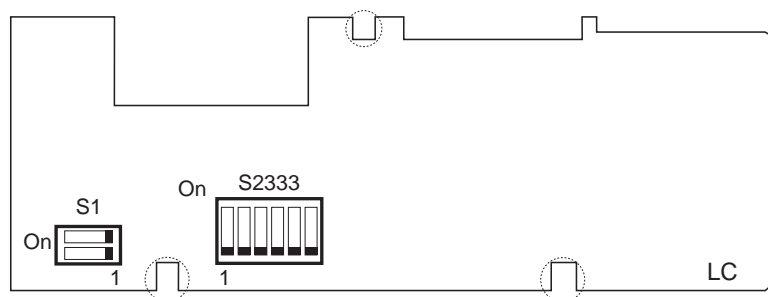

USCITA ANALOGICA W1 (DIP SWITCHES S2333)
 ANALOGUE OUTPUT W1 (DIP SWITCHES S2333)
 ANALOGER AUSGANG W1 (DIP SWITCHES S2333)
 SORTIE ANALOGIQUE W1 (DIP SWITCHES S2333)
 SALIDA ANALÓGICA W1 (DIP SWITCHES S2333)
 SAÍDA ANALÓGICA W1 (DIP SWITCHES S2333)

TIPO USCITA OUTPUT TYPE AUSGANGSTYP TYPE SORTIE TIPO DE SALIDA TIPO DE SAÍDA	SELEZIONE ON SELECTION ON WAHL ON SELECTION ON SELECCIÓN ON SELEÇÃO ON	SELEZIONE OFF SELECTION OFF WAHL OFF SELECTION OFF SELECCIÓN OFF SELEÇÃO OFF
0/4...20mA	5	4-6
0...10V	4-6	5

USCITA ANALOGICA W2 (DIP SWITCHES S2333)
 ANALOGUE OUTPUT W2 (DIP SWITCHES S2333)
 ANALOGER AUSGANG W2 (DIP SWITCHES S2333)
 SORTIE ANALOGIQUE W2 (DIP SWITCHES S2333)
 SALIDA ANALÓGICA W2 (DIP SWITCHES S2333)
 SAÍDA ANALÓGICA W2 (DIP SWITCHES S2333)

TIPO USCITA OUTPUT TYPE AUSGANGSTYP TYPE SORTIE TIPO DE SALIDA TIPO DE SAÍDA	SELEZIONE ON SELECTION ON WAHL ON SELECTION ON SELECCIÓN ON SELEÇÃO ON	SELEZIONE OFF SELECTION OFF WAHL OFF SELECTION OFF SELECCIÓN OFF SELEÇÃO OFF
0/4...20mA	2	1-3
0...10V	1-3	1

USCITA ALIMENTAZIONE TRASMETTITORE (DIP SWITCHES S1)
 TRANSMITTER SUPPLY OUTPUT (DIP SWITCHES S1)
 AUSGANG FÜR SENSORSPEISUNG (DIP SWITCHES S1)
 SORTIE DE ALIMENTATION POUR TRANSMETTEUR (DIP SWITCHES S1)
 SALIDA DE ALIMENTACIÓN PARA TRANSMISOR (DIP SWITCHES S1)
 SAÍDA DE ALIMENTAÇÃO PARA TRANSMISSOR (DIP SWITCHES S1)

TIPO USCITA OUTPUT TYPE AUSGANGSTYP TYPE SORTIE TIPO DE SALIDA TIPO DE SAÍDA	SELEZIONE ON SELECTION ON WAHL ON SELECTION ON SELECCIÓN ON SELEÇÃO ON	SELEZIONE OFF SELECTION OFF WAHL OFF SELECTION OFF SELECCIÓN OFF SELEÇÃO OFF
0V	-	1-2
10V	2	1
24V	1	2

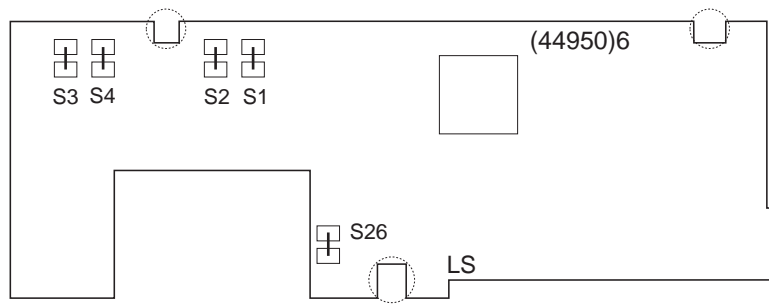

SCHEDA SERIALE / SPR
 SERIAL BOARD
 KARTE FÜR DIE SERIELLE ÜBERTRAGUNG
 CARTE SÉRIE
 FICHA SERIE
 PLACA DE COMUNICAÇÃO DIGITAL

INGRESSO SPR SPR INPUT SPR EINGANG ENTREE SPR ENTRADA ENTRADA	PONTICELLI (chiusi) JUMPERS (closed) BRÜCKEN (geschlossen) PONTS ÉTAIN (fermées) PUENTES (cerrados) PONTES (fechados)	PONTICELLI (aperti) JUMPERS (open) BRÜCKEN (geöffnet) PONTS ÉTAIN (ouvertes) PUENTES (abiertos) PONTES (abertos)
0/4...20mA	S4-S26	S1-S2-S3
0...10V / Potenziometro Potentiometer Potentiometer Potentiomètre Potenciómetro Potenciômetro	S1-S26	S2-S3-S4
TA 50mAac	S2-S3-S4	S1-S26